

WARNING: READ THE ASSEMBLING INSTRUCTIONS CAREFULLY BEFORE ASSEMBLING THE EZYSEAT INGROUND BENCH SEAT ONLY.

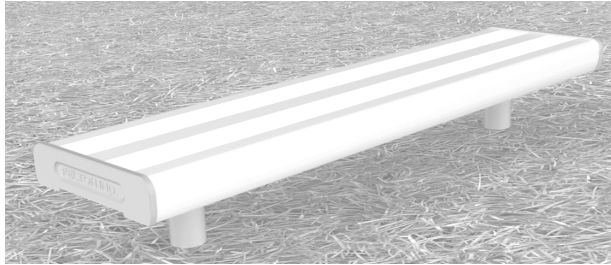



Make sure to wear protective gloves and foot protection when installing and assembling this product. Unpack the unit and make sure all the components are included before proceeding. This activity requires two or more people as lifting is involved. Please ensure bolts are only finger-tightened during the assembling process for flexibility in lining up components. Securely tighten the bolts before anchoring the product to the ground.





**1m. EZYSEAT INGROUND GROUND BENCH SEAT
(CODE No. EZYSIG1)**

ITEM PART	DESCRIPTION	QTY
ESIG1	SEAT LEG	2
ESIG2	1000 mm.—SEAT ALUMINIUM PLANK	1
ESIG3	M6x25 mm. HEXAGONAL HEAD BOLT	8
ESIG4	M6 LOCKNUT	8

ESIG1

ESIG2



ESIG3

ESIG4

Thank you for purchasing our high quality products. The Ezyseat InGround Bench Seat has been well manufactured with certified materials, to achieve high reliability and minimum maintenance. It is our commitment to provide you cost-effective solutions for outdoor applications.

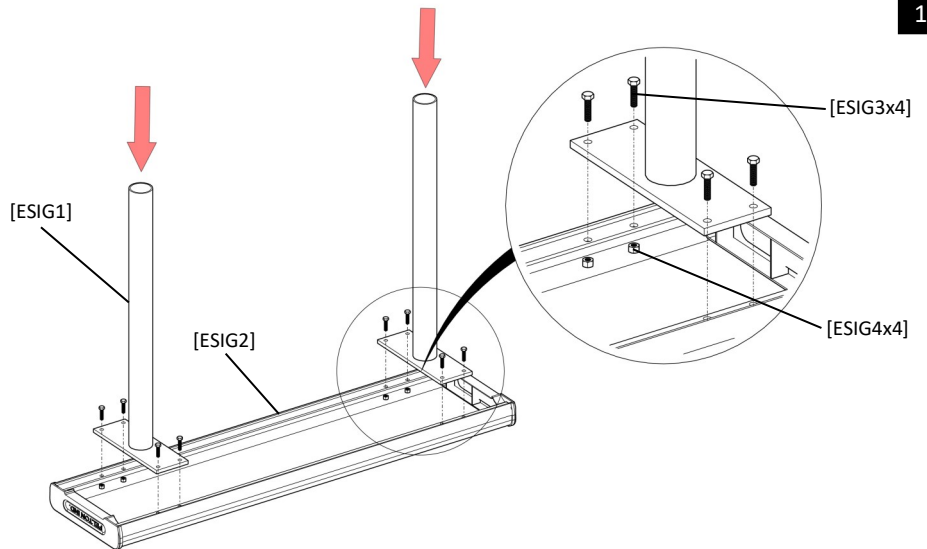

1



Place the table plank (**ESIG2**) up side down on a flat surface and attached it to the frames (**ESIG1**), by using hex. head bolts (**ESIG3**) and locknuts (**ESIG4**) — finger tighten.



2

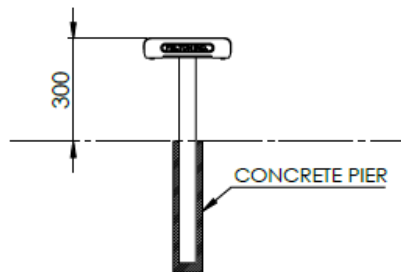

FRONT VIEW

Adjust all bolts properly with a span, wrench and/or any appropriate tool. Turn the bench seat up and fix it to the ground, by pouring concrete (Concrete piers).

The recommended seat height for 5-8 years infants is **300 mm**. (from the ground level to top seat plank as shown in the illustration).

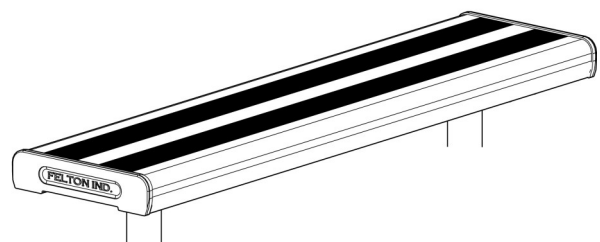
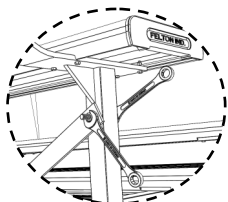

1