

WARNING: READ THE ASSEMBLING INSTRUCTIONS CAREFULLY BEFORE ASSEMBLING THE EZYSEAT FREE STANDING BENCH SEAT ONLY.

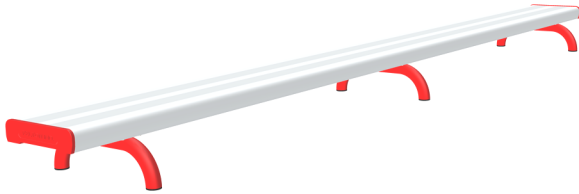

Make sure to wear protective gloves and foot protection when installing and assembling this product. Unpack the unit and make sure all the components are included before proceeding. This activity requires two or more people as lifting is involved. Please ensure bolts are only finger-tightened during the assembling process for flexibility in lining up components. Securely tighten the bolts before anchoring the product to the ground.



**3m. EZYSEAT FREE STANDING BENCH SEAT
(CODE No. EZYPFSS3)**

ITEM PART	DESCRIPTION	QTY
PFS1	SEAT LEG /FRAME	3
PFS2	3000 mm.—SEAT ALUMINIUM PLANK	1
ESIG3	M6x25 mm. HEXAGONAL HEAD BOLT	12
ESIG4	M6 LOCKNUT	12



PFS1

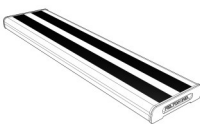

PFS2



PFS3



PFS4

Thank you for purchasing our high quality products. The Ezyseat Free Standing Bench Seat has been well manufactured with certified materials, to achieve high reliability and minimum maintenance. It is our commitment to provide you cost-effective solutions for outdoor applications.



1

Place the seat plank (PFS2) up side down on a flat surface and attached it to the frames (PFS1), by using hex. head bolts (PFS3) and locknuts (PFS4) — finger tighten.

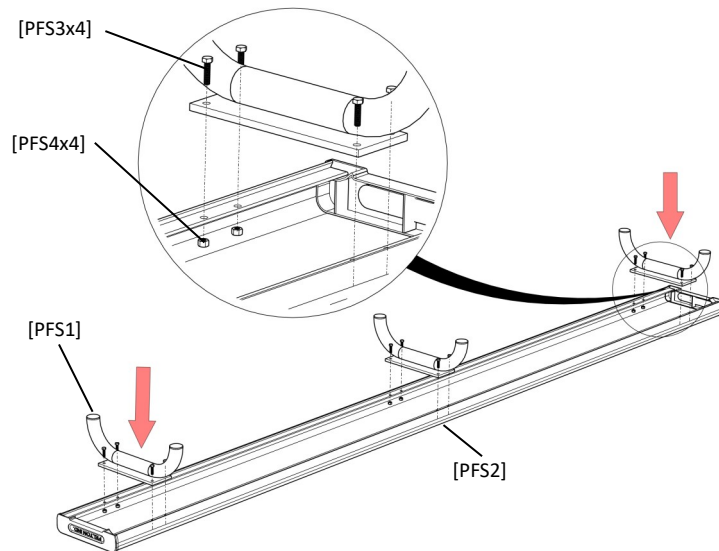

2

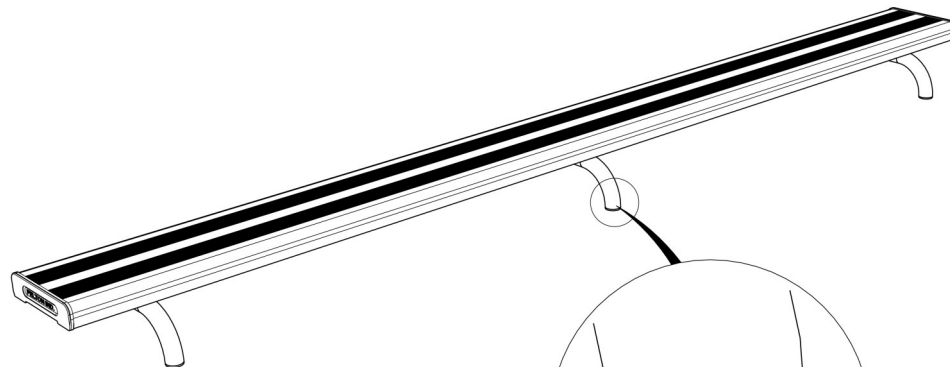

Adjust all bolts properly with a span, wrench and/or any appropriate tool. Turn the bench seat up and use it on firm level ground.

The PFS3 use is highly recommended for 1-2 years infants.

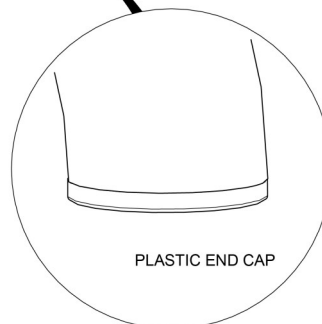
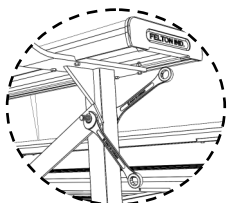

PLASTIC END CAP

1