

TABLES & CHAIRS

Interactive Wheelchair Setting

Code: FELIWS

There are no boundaries to communication with the Interactive Wheelchair Setting – everyone can actively join the conversation as seating is strategically placed for maximum interaction.



AUSTRALIAN
MADE & OWNED



UP TO 20% MORE
ALUMINIUM



7 YEAR
WARRANTY



BENCHMARK
ENGINEERING



PREMIUM
MATERIALS

Key Features

- Seats up to 8, including 2 wheelchairs
- DDA Compliant
- Maximising social interactions
- Coloured Safety End Caps available in red, blue, green, purple, yellow and orange

Ideal for

- Parks
- Aged Care
- Commercial Areas
- Hospitals



Specifications

Interactive Wheelchair Setting

Overall Plan: 2409mm L x 1740mm W x 838mm H

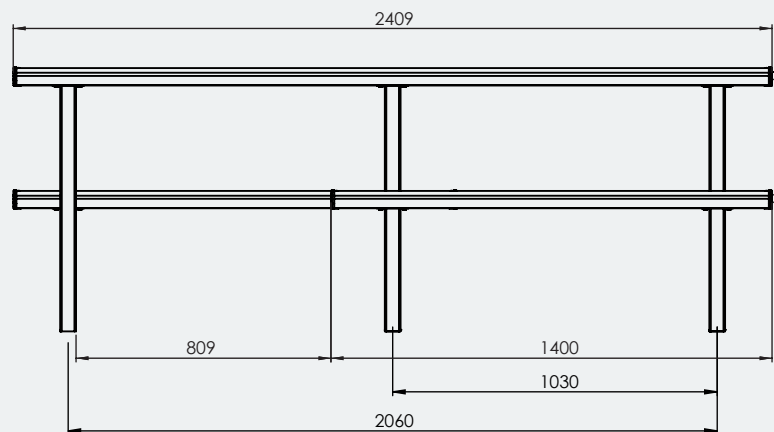
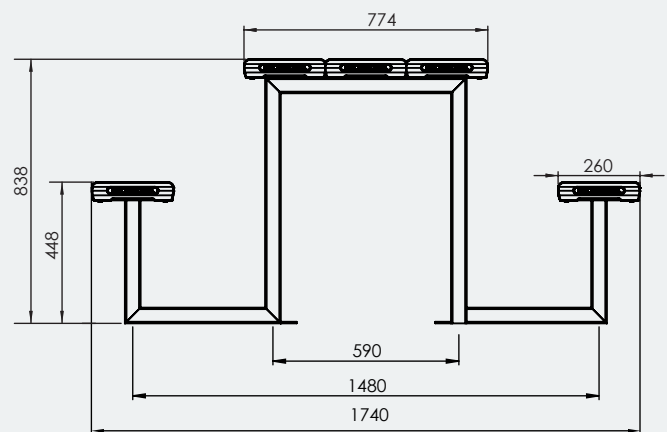

Table Top: 2409mmL x 774mm W x 838mm H

Seat Height: 448mm



A Division of Felton International Group Pty Ltd
ABN 17 130 687 240

