

GRANDSTANDS

2 Tier 4M Double Plank with Backrest Spectator Seating

Code: 2TGS3

Double plank tiers work to provide an added level of safety and comfort meaning the only thing going overboard will be the cheering. A popular choice throughout schools, gyms, clubs and sporting grounds.



Key Features

- 2 or 3 tiers available
- Seats between 10-12 or 16-18
- Great for narrow spaces
- Available as 2, 3 or 4 metre lengths
- Bolt down or free standing
- Backrest on the top tier
- Coloured Safety End Caps available in red, blue, green, purple, yellow and orange

Ideal for

- Sports Clubs
- Schools & Universities
- Council Grounds
- Any Outdoor Venue



Specifications

2Tier 4M Double Plank with Backrest Spectator Seating

Overall Plan: 1228mm D x 1019mm H x 4016mm L
(658mm H 2nd Tier)

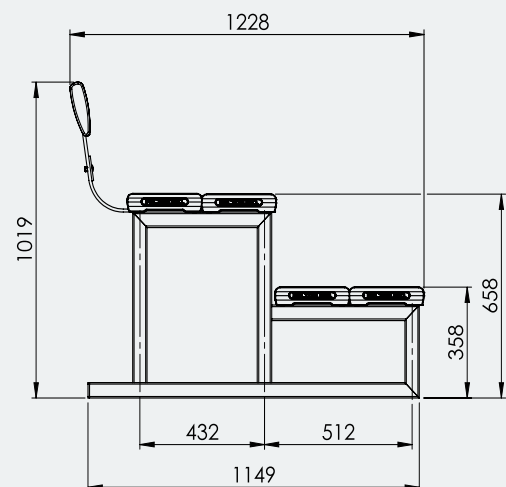
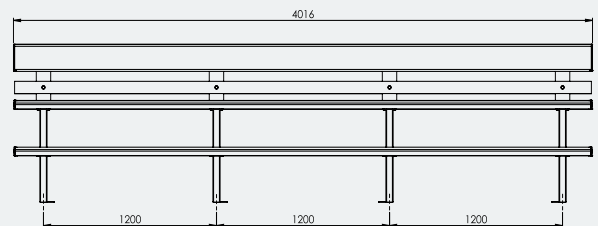

A Division of Felton International Group Pty Ltd
ABN 17 130 687 240

