

OUTDOOR SHELTERS

Interactive Eco-Trend Sheltered Park Setting

Code: FELIETSP

Interactive Eco-Trend Sheltered Park Setting forms part of the Eco-Trend range. The newest addition to the Felton range of shelters is proving to be a very popular choice for parkland and picnic areas.



Key Features

- Seats up to 6 people including 2 Wheelchairs
- DDA Compliant
- Maximum weather protection with Colorbond® Roof
- Latest in sleek design
- Bolt down lugs for maximum stability and safety
- Choice of colours available
- Coloured Safety End Caps available in red, blue, green, purple, yellow and orange

Ideal for

- Parks
- Aged Care
- Playgrounds
- Commercial Areas



Specifications

Interactive Eco-Trend Sheltered Park Setting

Overall Plan: 2324mm L x 1972mm W x 2576mm H

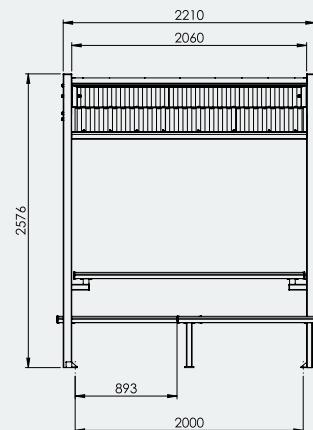
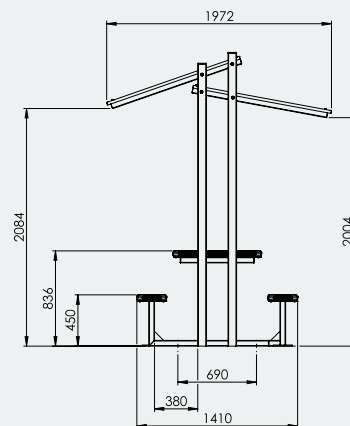

Table Top: 2000mm L x 690mm W x 836mm H



A Division of Felton International Group Pty Ltd
ABN 17 130 687 240

